

ITALY DESIGN & GERMANY TECHNOLOGY



Completely sealed
Crystal clear image
Non-corrosive
Ergonomic design
Saphire glass lense

The symbiosis of medical knowledge
and engineering know-how



RIGIDARTHROSCOPES

Minimalinvasive Diagnosis and Therapy



ARTHROSCOPY ENDOSCOPES

ITALY DESIGN & GERMANY TECHNOLOGY



High-end video - surgery system with a harmonious interplay of the individual components.



ARTHROSCOPY

The symbiosis of medical knowledge and engineering know-how



VIDEOSYSTEMS ARTHROSCOPY



Complete Arthroscopy work environment

1CCD VIDEO CAMERA "AD 750"

This camera ensures a correct color rendition, producing an outstanding image quality, by using a completely digital signal process. Compact and extremely efficient, the 1CCD is 1/3" more sensitive, ensuring a much higher resolution. The CCD gives a clear and captivatingly detailed picture for every endoscope application. The handling of the AD 750 is simple and flexible, ensuring high user safety.

Description	Item-No.
1CCD Camera AD750	900001
1CCD Camera AD750 +USB	900002
1CCD Camera AD750 +ZOOM	900003
1CCD Camera AD750 +USB+ZOOM	900004
Tv Adaptor F18mm	910001

XD-300

The Xenon 300 watt light source offers the professional user excellent illumination, for all endoscopic applications. The xenon lamp meets the highest requirements producing high light quantity with low heat emittance. The brightness regulation has a mechanical blank faceplate guaranteeing constant illumination of daylight quality. The light source cooler is extremely quiet and fulfils all necessary safety regulations. The lifetime indicator and the halogen replacement lamp provide safety.

Description	Item-No.
300 Watts Xenon Lightsource "XD 300"	900100
Spare Lamp 300W Xenon	900110
2meters light cable "U8724"	900200
3meters light cable "U8724"	900201



1-CHIP Camera

3-Chip Cameras and HD High Definition Cameras are also available

IF for HD Cameras, we recommend 16:9 monitor.

HD Cameras format:16:9. Real Full HD.



Xenon Lightsource 300WATTS

150 Watt Halogen and 250 Watt Halogen are also available

ESSE 3 Export SRL

Via Garibaldi 30
14022 castelnuovo DB,Italy
tel +39 011 99 27 706
fax +39 011 99 27 506
esse3@chierinet.it
info@4ci.com
www.4ci.com

Arthroscopy

Arthroscopes

AUTOCLAVABLE 134° C / 273° F

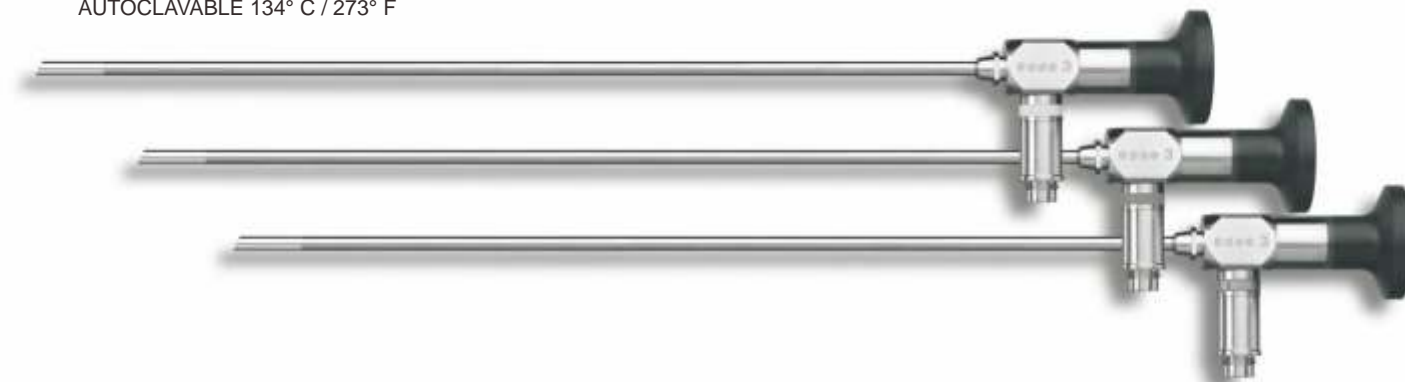

Rigid Arthroscopy

ARTHROSCOPES/SINUSCOPES/OTOSCOPES

Diameter	2.8mm	2.8mm	2.8mm	2.8mm	2.8mm
Length	100mm	110mm	110mm	110mm	140mm
Direction of View	0°	0°	30°	70°	0°
Angle	80°	80°	80°	80°	80°
Item-No.	500001	500002	500003	500004	500005

Diameter	2.8mm	2.8mm	2.8mm	2.8mm	2.8mm	2.8mm
Length	140mm	175mm	175mm	175mm	187mm	187mm
Direction of View	30°	0°	30°	70°	30°	30°
Angle	80°	80°	80°	80°	80°	80°
Item-No.	500006	500007	500008	500009	500010	500011

RIGID ARTHROSCOPES

Diameter	4mm	4mm	4mm
Length	175mm	175mm	175mm
Direction of View	0°	30°	70°
Angle	95°	95°	95°
Item-No.	500012	500013	500014

HD ARTHROSCOPE

Diameter	4mm	4mm	4mm
Length	175mm	175mm	175mm
Direction of View	0°	30°	70°
Angle	110°	110°	110°
Item-No.	500015	500016	500017

Arthroscopy

Arthroscopy Sheath with rotating stopcocks

Arthroscopy Sheath with two rotating stopcocks

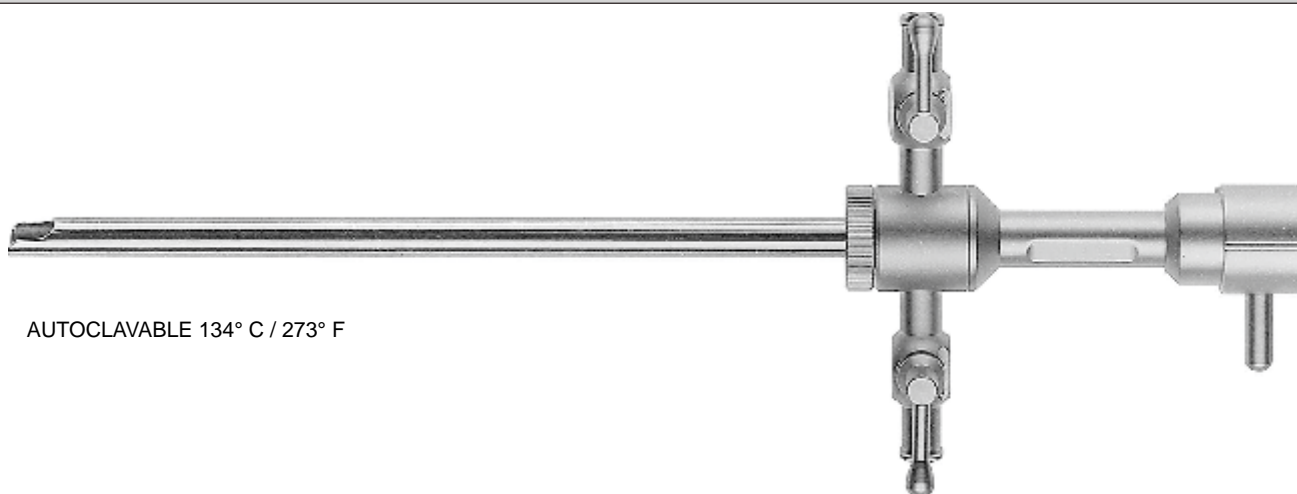

Scope Ø	Scope Length		Item-No.: universal
2,7 mm	175 mm		500018
2,7 mm	187,5 mm		500019
4,0 mm	175 mm		500020
5,0 mm	175 mm		500021

Arthroscopy

Trocars and Obturators for Arthroscopy Sheaths

Trocar pyramidal



AUTOCLAVABLE 134° C / 273° F

Scope Ø	Scope Length	Item-No.:	
2,7 mm	175 mm	500030	
2,7 mm	187,5 mm	500031	
4,0 mm	175 mm	500032	
5,0 mm	175 mm	500033	

Obturator blunt



AUTOCLAVABLE 134° C / 273° F

Scope Ø	Scope Length	Item-No.:	
2,7 mm	175 mm	500034	
2,7 mm	187,5 mm	500035	
4,0 mm	175 mm	500036	
5,0 mm	175 mm	500037	

Obturator blunt



AUTOCLAVABLE 134° C / 273° F

Scope Ø	Scope Length	Item-No.:	
2,7 mm	175 mm	500038	
2,7 mm	187,5 mm	500039	
4,0 mm	175 mm	500040	
5,0 mm	175 mm	500041	

Arthroscopy

Inflow- and Rinsing Cannulas

AUTOCLAVABLE 134° C / 273° F

Inflow-Cannula



Trocar pyramidal



Trocar blunt



Adapter



Inflow-Cannula	Scope Ø	Working Length	Item-No.:
complete	4,5 mm		500042
consisting of:			
Sheath only		70 mm	500043
Trocar pyramidal			500044
Trocar blunt			500045
Adapter			500046

AUTOCLAVABLE 134° C / 273° F

Rinsing Cannula with stopcock



Rinsing Cannula without stopcock



Obturator



Trocar



Rinsing Cannula with stopcock, Working Length 70 mm	Scope Ø	Item-No.:	Outer Ø	Item-No.:
complete	3,2 mm	822070	4,5 mm	500047
consisting of:				
Rinsing Cannula		822071		500048
Obturator		822072		500049
Trocar		822073		500050
Rinsing Cannula without Stopcock, Working Length 70 mm				
complete (Obturator + Trocar as mentioned above)	3,2 mm	822074		







Arthroscopy

Arthroscopes Instruments

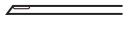
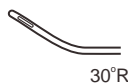
Punch & Scissors

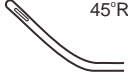
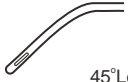

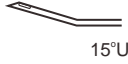
AUTOCLAVABLE 134° C / 273° F

Description		Hook scissors	Hook Punch with Scoop 1.6mm	Hook Punch Set Down 1.6mm	Hook Punch Cut Angular 1.6mm
Shaft length 130mm	Diam (mm)	Item-No.			
 Straight	2.7	500051	500069	500087	500105
	3.4	500052	500070	500088	500106
 30°Right	2.7	500053	500071	500089	500107
	3.4	500054	500072	500090	500108
 30°Left	2.7	500055	500073	500091	500109
	3.4	500056	500074	500092	500110
 45°Right	2.7	500057	500075	500093	500111
	3.4	500058	500076	500094	500112
 45°Left	2.7	500059	500077	500095	500113
	3.4	500060	500078	500096	500114
 7°Up	2.7	500061	500079	500097	500115
	3.4	500062	500080	500098	500116
 7°Down	2.7	500063	500081	500099	500117
	3.4	500064	500082	500100	500118
 15°Up	2.7	500065	500083	500101	500119
	3.4	500066	500084	500102	500120
 15°Down	2.7	500067	500085	500103	500121
	3.4	500068	500086	500104	500122







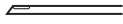

Arthroscopy

Arthroscopes Instruments

Hook Punch & Wide Jaw Punch

AUTOCLAVABLE 134° C / 273° F



Description		Hook Punch 15°Up 1.6mm	Wide Jaw Punch Large 4.5mm	Wide Jaw Punch Medium 3.5mm	Wide Jaw Punch Small 2.5mm
Shaft length 130mm	Diam (mm)	Item-No.			
 Straight	3.4	500123	500132	500141	500150
 30°Right	3.4	500124	500133	500142	500151
 30°Left	3.4	500125	500134	500143	500152
 45°Right	3.4	500126	500135	500144	500153
 45°Left	3.4	500127	500136	500145	500154
 7°Up	3.4	500128	500137	500146	500155
 7°Down	3.4	500129	500138	500147	500156
 15°Up	3.4	500130	500139	500148	500157
 15°Down	3.4	500131	500140	500149	500158







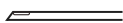

Arthroscopy

Arthroscopes Instruments

Wide Jaw Punch

AUTOCLAVABLE 134° C / 273° F



Description		Wide Jaw Punch 15°Up 4.5mm	Wide Jaw Punch 15°Up 3.5mm	Wide Jaw Punch 15°Up 2.5mm	Wide Jaw Punch 45°Up 2.0mm
Shaft length 130mm	Diam (mm)	Item-No.			
 Straight	3.4	500159	500168	500177	500186
 30°Right	3.4	500160	500169	500178	—
 30°Left	3.4	500161	500170	500179	—
 45°Right	3.4	500162	500171	500180	—
 45°Left	3.4	500163	500172	500181	—
 7°Up	3.4	500164	500173	500182	—
 7°Down	3.4	500165	500174	500183	—
 15°Up	3.4	500166	500175	500184	—
 15°Down	3.4	500167	500176	500185	—

Arthroscopy

Arthroscopes Instruments

Punch & Hook Scissors

AUTOCLAVABLE 134° C / 273° F



					
Description		Punch 45° With Scoop 1.6mm	Punch 45° Blunt 1.6mm	Punch 90° With Scoop 1.6mm	Punch 90° Blunt 1.6mm
Shaft length 130mm	Diam (mm)	Item-No.			
Right angled	2.7	500187	500189	500191	500193
Left angled	2.7	500188	500190	500192	500194

					
Description		Hook Scissors 45°	Punch 45° With Scoop 1.6mm	Punch 90° With Scoop 1.6mm	Punch 90° With Scoop 1.6mm
Shaft length 130mm	Diam (mm)	Item-No.			
Right angled	3.4	500195	500197	500199	500201
Left angled	3.4	500196	500198	500200	500202

Right angled	3.4		500203
Left angled	3.4		500204
		Punch 90° Blunt 1.6mm	

Arthroscopy

Arthroscopes Instruments

Wide Jaw Punch 90°

AUTOCLAVABLE 134° C / 273° F



			
Description		Wide Jaw Punch 90°Medium 3.0mm	Wide Jaw Punch 90°Small 2.0mm
Shaft length 130mm	Diam (mm)	Item-No.	
Right angled	3.4	500205	500207
Left angled	3.4	500206	500208







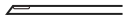

Arthroscopy

Arthroscopes Instruments

Scissors Punch & Punch

AUTOCLAVABLE 134° C / 273° F

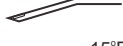

Description		Scissors Punch 0.8mm	Scissors Punch 15°Up 0.8mm	Punch Retrograde Cut left 2.5mm	Punch Retrograde Cut Right 2.5mm
Shaft length 130mm	Diam (mm)	Item-No.			
 Straight	3.4	500209	500218	500227	500228
 30°Right	3.4	500210	500219	—	—
 30°Left	3.4	500211	500220	—	—
 45°Right	3.4	500212	500221	—	—
 45°Left	3.4	500213	500222	—	—
 7°Up	3.4	500214	500223	—	—
 7°Down	3.4	500215	500224	—	—
 15°Up	3.4	500216	500225	—	—
 15°Down	3.4	500217	500226	—	—

Arthroscopy

Arthroscopes Instruments

Punch & Hook Scissors

AUTOCLAVABLE 134° C / 273° F



					
Description		Punch 45° With Scoop 1.6mm	Punch 45° Blunt 1.6mm	Punch 90° With Scoop 1.6mm	Punch 90° Blunt 1.6mm
Shaft length 130mm	Diam (mm)	Item-No.			
Without Ratchet	2.7	500229	500231	500233	500235
With Ratchet	2.7	500230	500232	500234	500236

					
Description		Hook Scissors 45°	Punch 45° With Scoop 1.6mm	Punch 90° With Scoop 1.6mm	Punch 90° With Scoop 1.6mm
Shaft length 130mm	Diam (mm)	Item-No.			
Without Ratchet	3.4	500237	500239	500241	500243
With Ratchet	3.4	500238	500240	500242	500244

Without Ratchet	3.4		500245
With Ratchet	3.4		500246
		Punch 90° Blunt 1.6mm	

Arthroscopy

Arthroscopes Instruments

Hoen Grasping Alligator Forceps

Retrieving tendons or foreign bodies

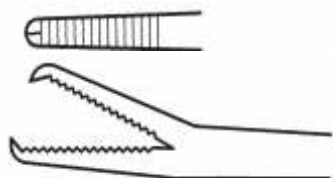

Length(mm)	Description	Item-No.
140	Serrated jaw with 1x2 tip	500248











Loose Body Grasper



Length(mm)	Description	Item-No.
140	Serrated jaw with blood groove	500249
120	Serrated jaw with blood groove	500250









Arthroscopy

Arthroscopes Instruments -Fixed handle Probe & Curette & File & Knife & Meniscotome

	Description	Item-No.
	Meniscus Probe 2.5mm	500251
	Meniscus Probe 3.5mm / 5.4mm	500252 / 500252-1
	Bayonet Knife	500253
	Scapel Knife	500254
	Smillie Meniscotome 3.0mm	500255
	Smillie Meniscotome 5.0mm	500256
	Smillie Meniscotome 7.0mm	500257
	Ring Curette 3.0mm	500258
	Ring Curette 5.0mm	500259
	Spoon 3.0mm	500260

Arthroscopy

Arthroscopes Instruments--Fixed handle Probe & Currette & File & Knife & Meniscotome

	Description	Item-No.
	Banana Knife Smooth	500261
	Banana Knife Serrated	500262
	Hook knife(small / big)	500263 / 500263-1
	Planing Knife	500264
	Sickle Knife	500265
	Rosette Knife 5.0mm	500266
	Cartilage File Fine	500267
	Smillie Meniscotome 3.0mm 60 Right	500268
	Smile Meniscotome 3.0mm 60 Left	500269

Arthroscopy

Arthroscopes Instruments

Suction Punch



Shaft Length(mm)	Description	Item-No.
110	Suction Punch Handle	500270

	Description	Item-No.
	Punch head 3.5mm	500271
	Punch head 4.5mm	500272
	Punch head 5.5mm	500273



Complete Arthroscopy work enviroment

ES-APU-10

Combination working with Arthroscope shaver, the unique interfrated pressure sensing system provides instantaneous safety, precise adjustment throughout the whole operation procedure.

Description	Item-No.
ES-APU-10, Complete	902000



ES-SHA-10

Unique shaving performance, highest precision, strong power and durability also under difficult operation condition, which provides the surgery accurate safe and successful.

Description	Item-No.
ES-SHA-10, Complete	901000
Hand Piece	901001
Foot Switch	901002



ESSE 3 Export SRL

Via Garibaldi 30
14022 castelnuovo DB,Italy
tel +39 011 99 27 706
fax +39 011 99 27 506
esse3@chierinet.it
info@4ci.com
www .4ci .com





Arthroscopy

Shaver accessories

Shaver Blade



AUTOCLAVABLE 134° C / 273° F

	Description	Item-No.		
		2.5mm	4.2mm	5.5mm
	Full Radius Resector	901003	901004	901005
	Aggressive Full Radius	901006	901007	901008
	Aggressive Meniscus Cutter	—	901009	901010
	Round Burr	—	901011	901012
	Tapered Burr	—	901013	901014